

KOHLER®

UNINTERRUPTIBLE
POWER



KOHLER **PW** 3000/P1

(10 & 20 kVA)

Parallelable up to 80 kVA/kW

User Manual



Please comply with all warnings and operating instructions in this manual. This equipment should only be installed, serviced, and maintained by qualified personnel. Do not operate this unit before reading through all safety information and operating instructions carefully.

Disclaimer

We assume no responsibility or liability for loss or damages, whether direct, indirect, consequential or incidental, which might arise out of the use of such information. The use of any such information will be entirely at the user's risk. Information in this manual is subject to change without notice. We make no commitment to update or keep current the information in this manual. If you find information in this manual that is incorrect, misleading, or incomplete, we would appreciate your comments and suggestions.

Table of Contents

1. SAFETY AND EMC INSTRUCTIONS	1
1-1. TRANSPORTATION AND STORAGE.....	1
1-2. PREPARATION.....	1
1-3. INSTALLATION	1
1-4. CONNECTION WARNINGS	2
1-5. OPERATION	3
1-6. STANDARDS	3
2. INSTALLATION AND OPERATION	4
2-1. UNPACKING AND INSPECTION	4
2-1-2 POSITIONING	4
2-2. REAR SYSTEM VIEW	5
2-3. SINGLE UPS INSTALLATION.....	8
2-4. UPS INSTALLATION FOR PARALLEL SYSTEM.....	10
3. OPERATIONS	11
3-1. INITIAL OPERATION	11
3-2. SCREEN DESCRIPTION	11
3-3. AUDIBLE ALARM	26
3-4. SINGLE UPS OPERATION	26
3-5. PARALLEL OPERATION	29
3-6. FAULT CODE.....	31
3-7. WARNING CODE	31
4. TROUBLE SHOOTING	32
5. STORAGE AND MAINTENANCE	33
5-1. STORAGE	33
5-2. MAINTENANCE	33
6. SPECIFICATIONS	34
7. OPTIONS	35
7-1 SNMP CARD - OPTIONAL	35

1. Safety and EMC instructions

All safety instructions in this document must be read, understood and followed.

1-1. Transportation and Storage



Please transport the UPS system only in the original packaging to protect against shock and damage.



The UPS must be stored in a room where the temperature is well regulated. Ambient temperature should not exceed 40°C.

1-2. Preparation



Condensation may form if the UPS system is moved instantly from a cold to warm environment. The UPS system must be dry before being installed. Please allow at least two hours for the UPS system to acclimatise to the environment.



Do not install the UPS system near water or in humid environments.



Do not install the UPS system where it would be exposed to direct sunlight or nearby heat source.



Do not block ventilation holes on the UPS housing.

1-3. Installation



Do not connect appliances or devices which would overload the UPS (e.g. big motor-type equipment) to the UPS output terminal.



Place cables in such a way that no one can step on or trip over them.



Do not block air vents on the housing of the UPS. Ensure proper unit spacing of ventilation.



UPS chassis must both be connected to Site Potential Earth Terminals. Battery chassis must have a Potential Earth connection directly to UPS, or the battery chassis must be connected to site Potential Earth terminals directly.



The UPS must be installed only by a qualified engineer.



An appropriate disconnect device such as short-circuit backup protection should be incorporated during installation.



An integral emergency shutoff switch which prevents additional load from the UPS in any mode of operation should be implemented during the installation.



Secure the grounding/earthing wire to the terminal before connecting any live cable.



Installation and Wiring must be in accordance with the local electrical laws and regulations.

1-4. ⚠ Connection Warnings

- There is no standard backfeed protection inside of the UPS. However, there are relays on the Input to cut off line voltage and while the neutral is still connected to UPS.

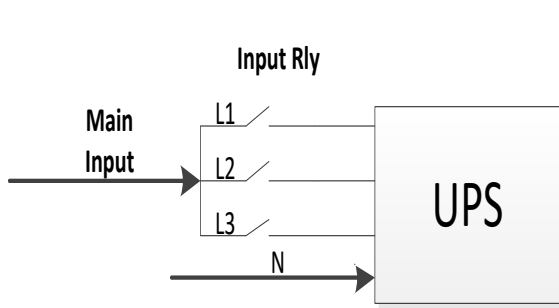

Input relay diagram

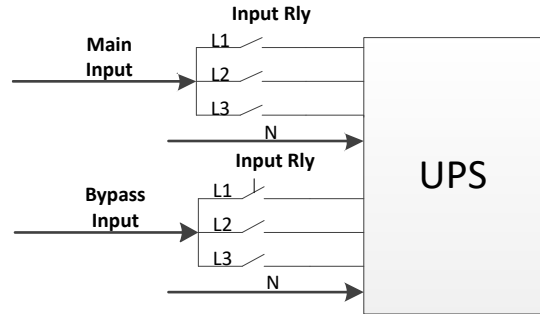

Input relay diagram for dual-input model

- This UPS should be connected with a **TN** grounding/earthing system.
 - The power input for this unit must be three-phase rated in accordance with the equipment nameplate. It also must be suitably grounded.

WARNING
HIGH LEAKAGE CURRENT
EARTH CONNECTION ESSENTIAL
BEFORE CONNECTING SUPPLY

- Use of this equipment in medical instrument or any life-sustaining equipment where failure of this equipment can reasonably be expected to cause the failure of the life-sustaining equipment or to significantly affect its safety or effectiveness is not recommended. Do not use this equipment in the presence of a flammable mixture with air, oxygen or nitrous oxide.
- Connect grounding terminal of UPS to a grounding electrode conductor.
- In accordance with safety standard EN-IEC 62040-1, installation must be provided with a «Backfeed Protection» system, as for example a contactor, which will prevent the appearance of voltage or dangerous energy in the input mains during a mains fault. (Respect the wiring diagram of «Backfeed Protection» depending on if the equipment is with signal or three phase input).



There shouldn't be a spur circuit from the «Backfeed Protection» to the UPS, as the standard safety would be infringed.





- Warning labels should be placed on all primary power switches installed in places away from the unit to alert the electrical maintenance personnel of the presence of a UPS in the circuit. The label will bear the following or an equivalent text:

Before working on this circuit

- Isolate Uninterruptible Power Supply (UPS)
- Then check for Hazardous Voltage between all terminals including the protected earth

Risk of Voltage Backfeed

1-5. Operation

-  Do not disconnect the grounding/earthing conductor cable on the UPS or to the building wiring terminals under any circumstance.
-  The UPS system features its own, internal current source (batteries). The UPS output sockets or output terminal blocks may be electrically live even if the UPS system is not connected to the building mains/live wires. (only for standard models)
-  In order to fully disconnect the UPS system, first press the "OFF" button and then disconnect the mains/live cables.
-  Ensure that no liquid or other foreign objects can enter into the UPS system.
-  The UPS can be operated by any individuals with no previous experience.

1-6. Standards

* Safety	
IEC/EN 62040-1	
* EMI	
Conducted Emission.....:IEC/EN 62040-2	Category C3
Radiated Emission.....:IEC/EN 62040-2	Category C3
*EMS	
ESD.....:IEC/EN 61000-4-2	Level 4
RS.....:IEC/EN 61000-4-3	Level 3
EFT.....:IEC/EN 61000-4-4	Level 4
SURGE.....:IEC/EN 61000-4-5	Level 4
CS.....:IEC/EN 61000-4-6	Level 3
Power-frequency Magnetic field.....:IEC/EN 61000-4-8	Level 4
Low Frequency Signals.....:IEC/EN 61000-2-2	
Warning: This is a product for commercial and industrial application in the second environment-installation restrictions or additional measures may be needed to prevent disturbances.	

2. Installation and Operation

2-1. Unpacking and Inspection

Unpack the package and check the package contents. The shipping package should contain:

- One UPS
- One user manual
- One monitoring software CD
- One RS-232 cable (option)
- One USB cable
- One parallel cable (only available for parallel model)
- One shared current cable (only available for parallel model)
- 1 x 2Way / 1 x 3Way / 1 x 4Way DIN Terminal Jumper Bars

NOTE: Before the installation, please inspect the unit. Be sure that there is no physical damage to the unit. Do not turn on the unit and notify the carrier and dealer immediately if there is any damage or missing parts and accessories. Please keep the original packaging for future use. It is recommended to keep each equipment and battery set in their original packaging because they have been designed to provide maximum protection during transportation and storage.

2-1-2 Positioning

The UPS system is on wheels and can be moved on a solid floor.

The "Positioning Diagram" below details the recommended clearance space around the UPS for correct air flow.

100mm is recommended between cabinets and 200mm behind the UPS cabinet.

Terminals are located on rear of UPS and access should be provided during installation and maintenance.

NOTE: For Maintenance purposes 600mm side clearance is required to access batteries and components on both sides. If 600mm side clearance is not available, extra cable should be fitted to allow the UPS to be withdrawn from its position to allow access.

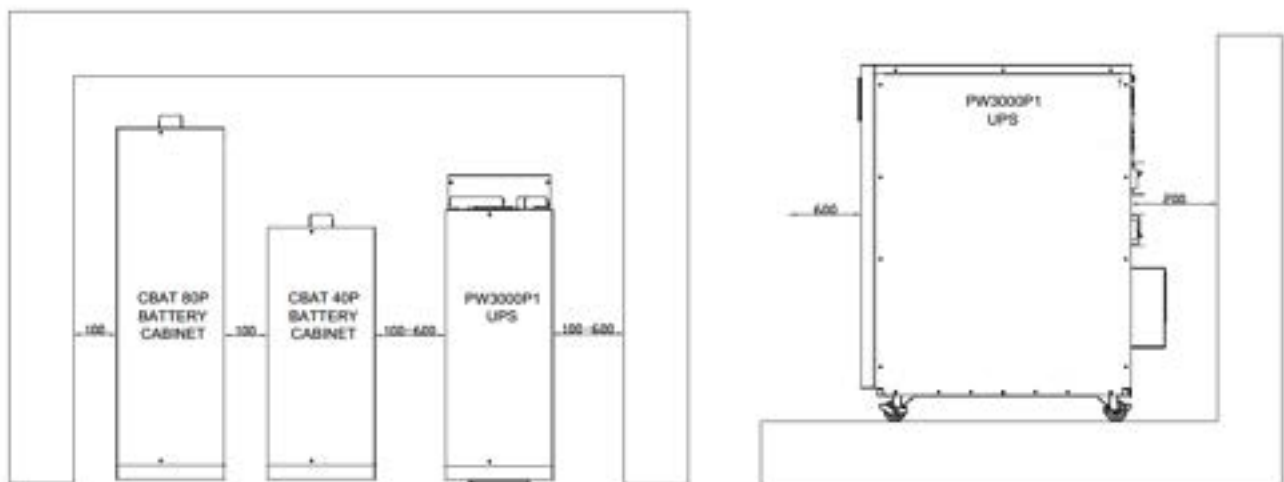

Positioning Diagram

2-2. Rear System View

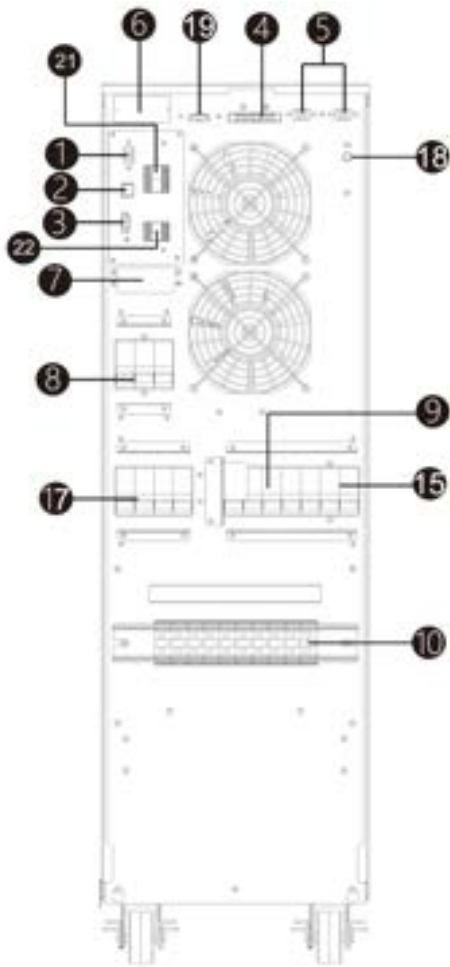

Diagram 1 Rear Panel

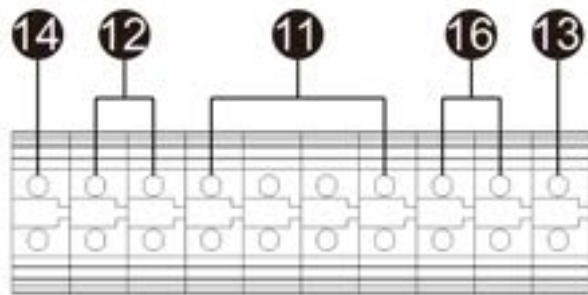
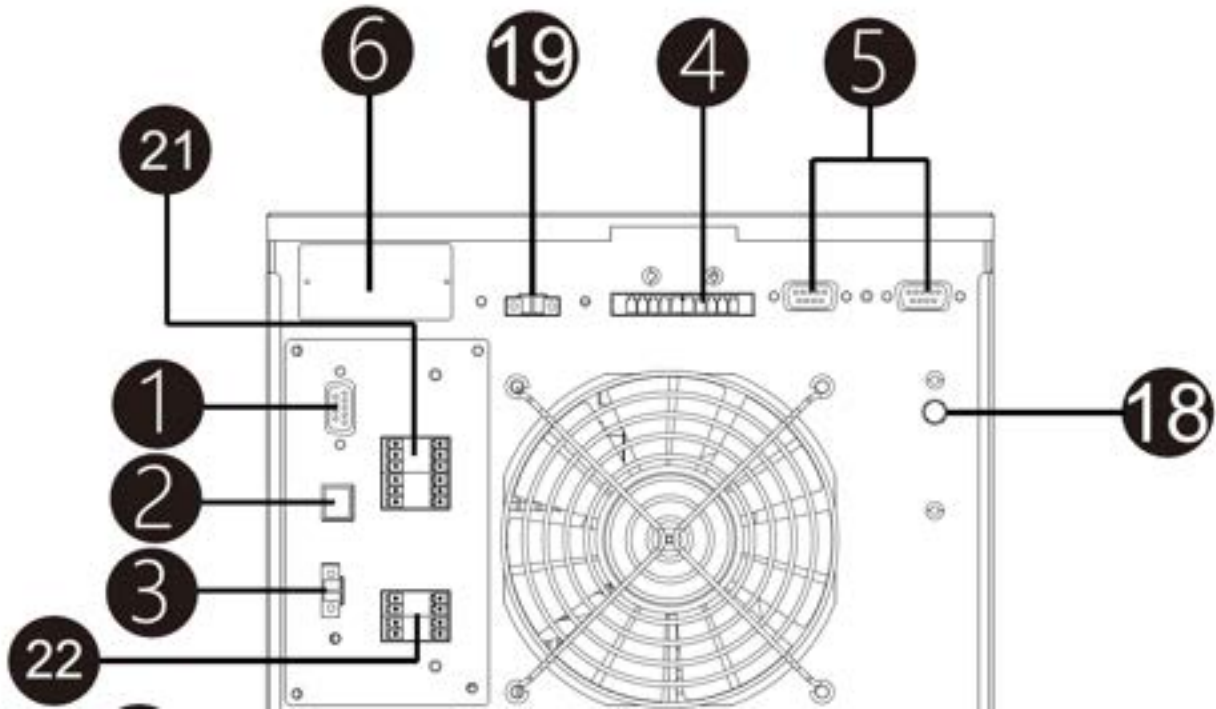

Diagram 2: Input/Output terminals

1. RS-232 port
2. USB communication port
3. Emergency power off connector (EPO connector)
4. Parallel Share current port
5. Parallel port
6. Intelligent slot – SNMP or DRY Port
7. External battery connector/terminal
8. Line input circuit breaker/switch
9. Maintenance bypass switch
10. Input/Output terminals (Refer to diagram 2 for the details)

11. Line input terminals
12. Output terminal
13. Input ground terminal
14. Output ground terminal
15. Bypass input circuit breaker/switch
16. Bypass input terminals
17. Output switch
18. Service start
19. External Maintenance Bypass Switch connector (EMBS)
21. Input Dry Port Terminals
22. Output Dry Port Terminals



1. **RS232 Port** – Port is used by Maintenance Service engineer to enable updates to internal firmware of the UPS System. Not for Customer Use
2. **USB Port** – Communication port for Customer to connect monitoring Software directly to local PC, provides Alarms and functional monitoring.
3. **EPO** – EPO port is NC in normal Operation. Breaking this NC loop forces the UPS Inverter to disconnect the output to the load.
4. **Parallel Share Current Port** – Used when multiple UPS systems are connected in Parallel
5. **Parallel Port** – Used when multiple UPS systems are connected in Parallel
6. **SNMP CARD SLOT** – One Slot provided can hold optional SNMP card.
18. **SERVICE START** – Allows UPS to be started directly from the battery with no incoming mains supplied.
19. **EMBS (External Maintenance Bypass Switch)** – Port is NC in Normal Operation.
 The EMBS port can be linked to an external Maintenance bypass switch to ensure an interlock is connected to the UPS internal static switch. When installed and the EMBS is closed the Inverter is shutdown and the static transfer switch connects the load directly to the incoming mains supply.

21. INPUT DRY PORT

Provides up to 8 input functions for operating UPS system

Contact	Message	Description
1	Remote on	Remote activation to switch UPS on
2	Remote Off	Remote activation to switch UPS off (to bypass)
3	Shutdown - Restore	UPS stops and restarts in 1min
4	Generator Detection	Activates internal generator functions.
5	External Output Switch	When external Output switch is Open, the following alarm code is active (45) External Output Switch Open . UPS disconnect from the parallel System
6	BATCB	when battery breaker or switch is Open, the following alarm code is active (46) Battery Switch Open .
7	BYPCB	when bypass input breaker or switch is Open, the following alarm code is active (47) Bypass Switch Open .
8	LINECB	when line input breaker or switch is Open, the following alarm code is active (48) Input Breaker Open .

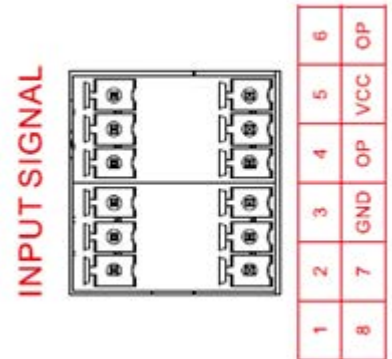

22. OUTPUT DRY PORT

Provides up to 6 output functions for monitoring the UPS system, max 1A 24V connection.

Dry ports can be configured NO or NC by service engineer.

Contact	Message	Description
1	Line Failure	The Input voltage or frequency is abnormal.
2	Load on Inverter	UPS is in Inverter mode.
3	Battery Low	Low Battery – Battery near to the end of Autonomy
4	Load on bypass	UPS is in Bypass mode.
5	General Alarm	General Alarm (Bypass Mode / Battery Mode / Battery Open / Bypass Loss / UPS Fault / UPS Warning / Line Fault)
6	Overtemperature	UPS System Temperature is High

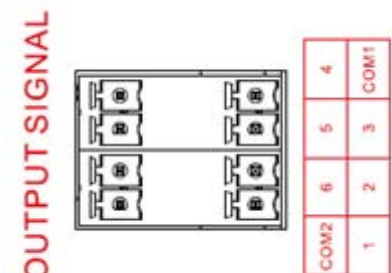

2-3. Single UPS Installation

Installation and wiring must be carried out in accordance with the local installation regulations by trained professionals.

1) Make sure that the mains cable and breakers of the building are rated for the capacity of the UPS to prevent electric shock or risk of fire.

NOTE: Do not use a standard wall mains socket as the input power source for the UPS, as its rated current is less than the UPS's maximum input current. The socket may be damaged and destroyed.

2) Switch off the mains switch in the building before installation.

3) Turn off all the connected devices before connecting to the UPS.

4) Prepare cables based on the following table:

Model	Wiring spec (mm ² & Max A Per Phase)							
	Bypass Input (if used)	Input (1Ph)	Input (3Ph) SINGLE	Input (3Ph) DUAL	Output (Ph)	Neutral	Battery	Ground
PW3000/P1 10K	10mm (67A)	10mm (67A)	10mm (67A)	4mm (23A)	10mm (45A)	10mm	10mm (60A)	10mm
PW3000/P1 20K	25mm (132A)	25mm (132A)	25mm (132A)	10mm (45A)	25mm (86A)	25mm	25mm (110A)	25mm

NOTE 1: The selection for cable sizing should be based on the cable specification used and the type of cable installation. Local electrical laws and regulations should be followed.

NOTE 2: The selections for colour of cables should be followed by the local electrical laws and regulations.

NOTE 3: Maximum current is based on Input Voltage of 209V, 130% load with 12A Charger fully operating.

5) Remove the terminal block cover at the rear panel of UPS. Then connect the wires according to the following terminal block diagrams: (Connect the grounding/earthing wire first when making wire connections. Disconnect the earth wire after you disconnect the power wire.)

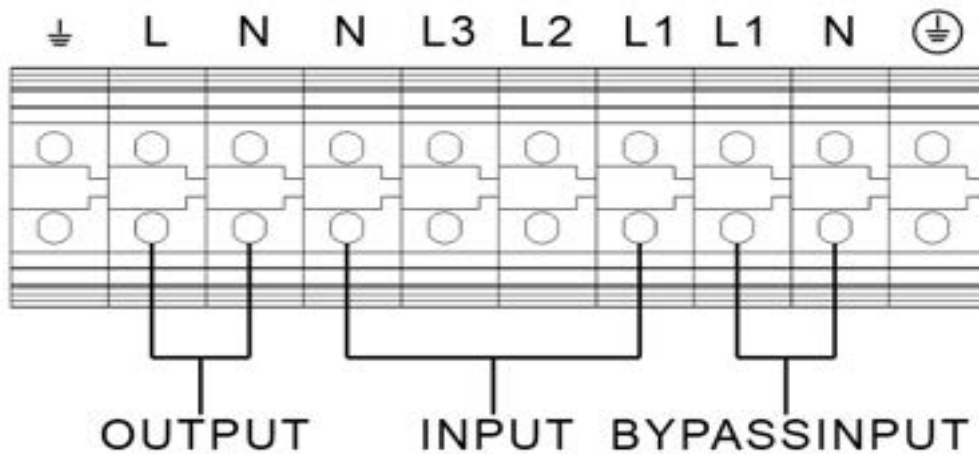

Terminal block wiring diagram

NOTE 1: Make sure that the wires are connected tightly with the terminals.

6) Put the terminal block cover back at the rear panel of the UPS.

The KOHLER PW 3000/P1 System Can be modified to operate at various configurations of inputs. To change the configuration, insert or remove the provided jumper bars on the terminal rail as detailed below:

SINGLE FEED - 3 PHASE INPUT

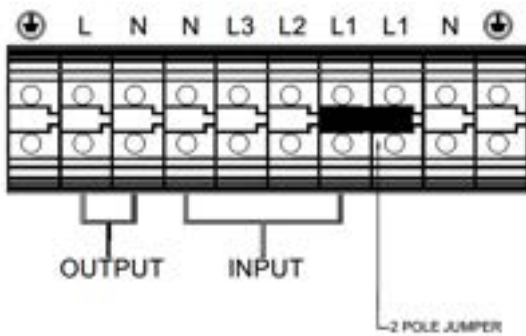

SINGLE FEED - 1 PHASE INPUT

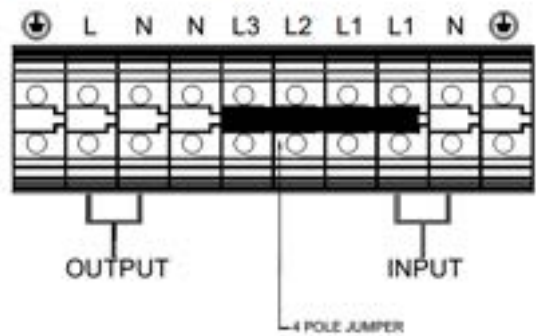

DUAL FEED - 3 PHASE INPUT

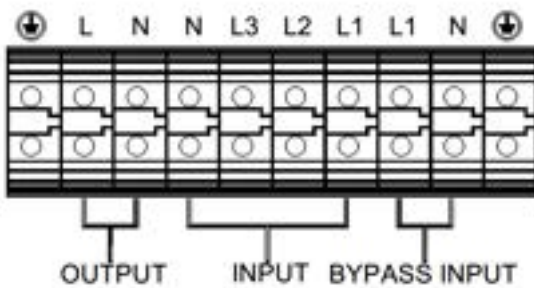

DUAL FEED - 1 PHASE INPUT

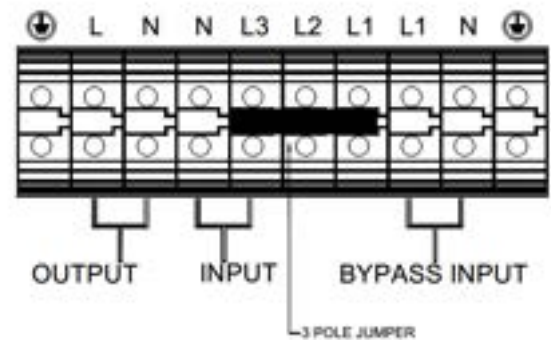

Warning:

- Make sure a DC breaker or other protective device between UPS and the external battery pack is installed. Switch off the battery breaker before installation.

NOTE: Set the battery pack breaker in "OFF" position and then install the battery pack.

- Pay attention to the rated battery voltage marked on the rear panel. If you want to change the numbers of the battery pack, please make sure you modify the setting simultaneously. The Connection with wrong battery voltage may cause permanent damage to the UPS. Make sure the voltage of the battery pack is correct.
- Pay attention to the polarity marking on external battery terminal block and make sure the correct battery polarity is connected. Wrong connection may cause permanent damage to the UPS.
- Make sure the protective earth ground wiring is correct. The wire current spec, colour, position, connection and conductance reliability should be checked carefully.
- Make sure the utility input & output cable is sized correctly. The cable current spec, colour, position, connection and conductance reliability should be checked carefully. Make sure the L/N side is correct, not reverse or short-circuited.

2-4. UPS Installation for Parallel System

If the UPS is being installed for single operation, you may skip this section.

- 1) Connect the Parallel (dash lines) & Current Share cables as per the following drawings:

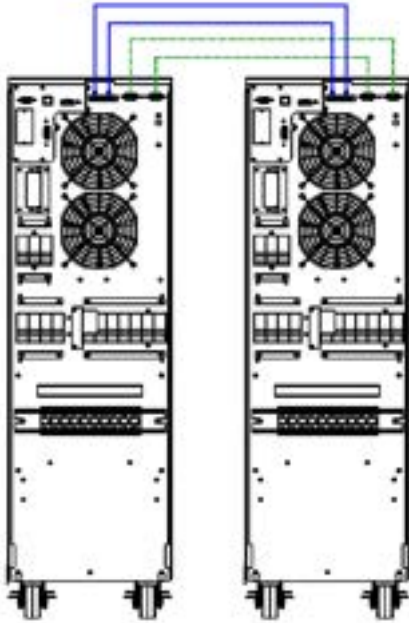

2 X SYSTEM IN PARALLEL

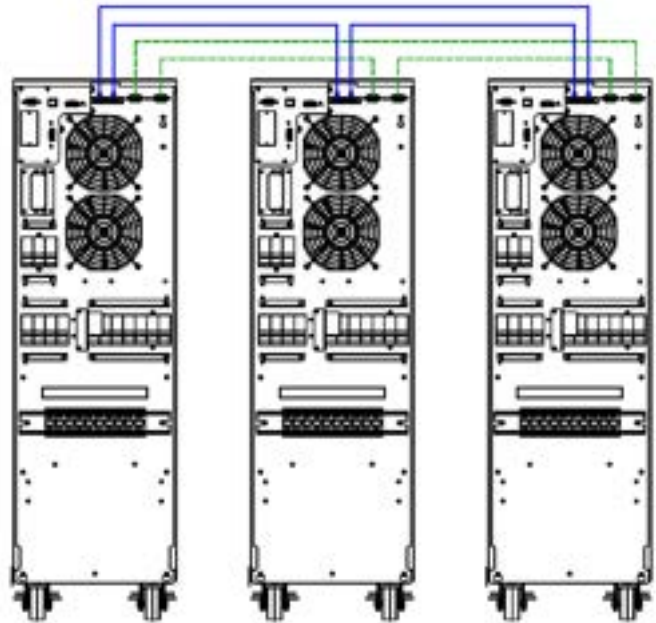

3 X SYSTEMS IN PARALLEL

- 2) Install and cable the UPS according to the section 2-3.
- 3) Connect the output cables of each UPS to a separate output breaker.
- 4) Connect the input cables of each UPS to a separate input breaker.
- 5) Connect all output breakers to a main output breaker. Then this main output breaker will directly connect to the loads.
- 6) Common battery packs or independent battery packs can be installed.
- 7) Refer to the following wiring diagram:

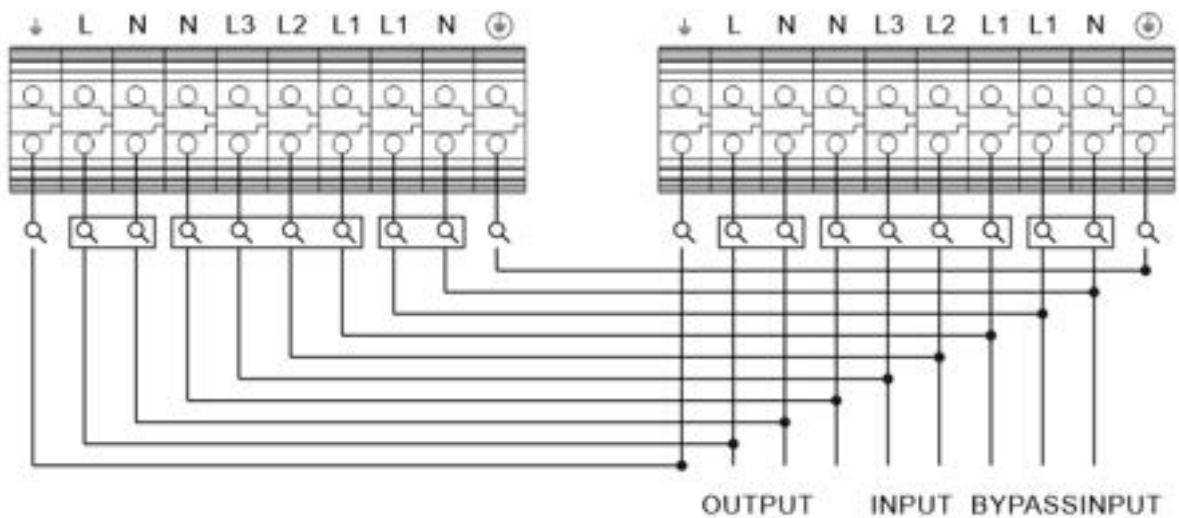

Wiring diagram of parallel system

3. Operations

3-1. Initial Operation

- 1) Before operation, make sure that the two string halves of batteries are connected correctly in order of "+,GND,-" terminals and the breaker of the battery pack is at "ON" position.
- 2) Start up UPS system by closing the Input and Bypass breakers, check all settings and configurations before starting up the UPS fully in section 3-4.

3-2. Screen description

After initialisation, the LCD will display main screen. There are five sub-menus: Control, measure, setting, information and data log. Touch any sub-menu icon to enter into the sub-screen.

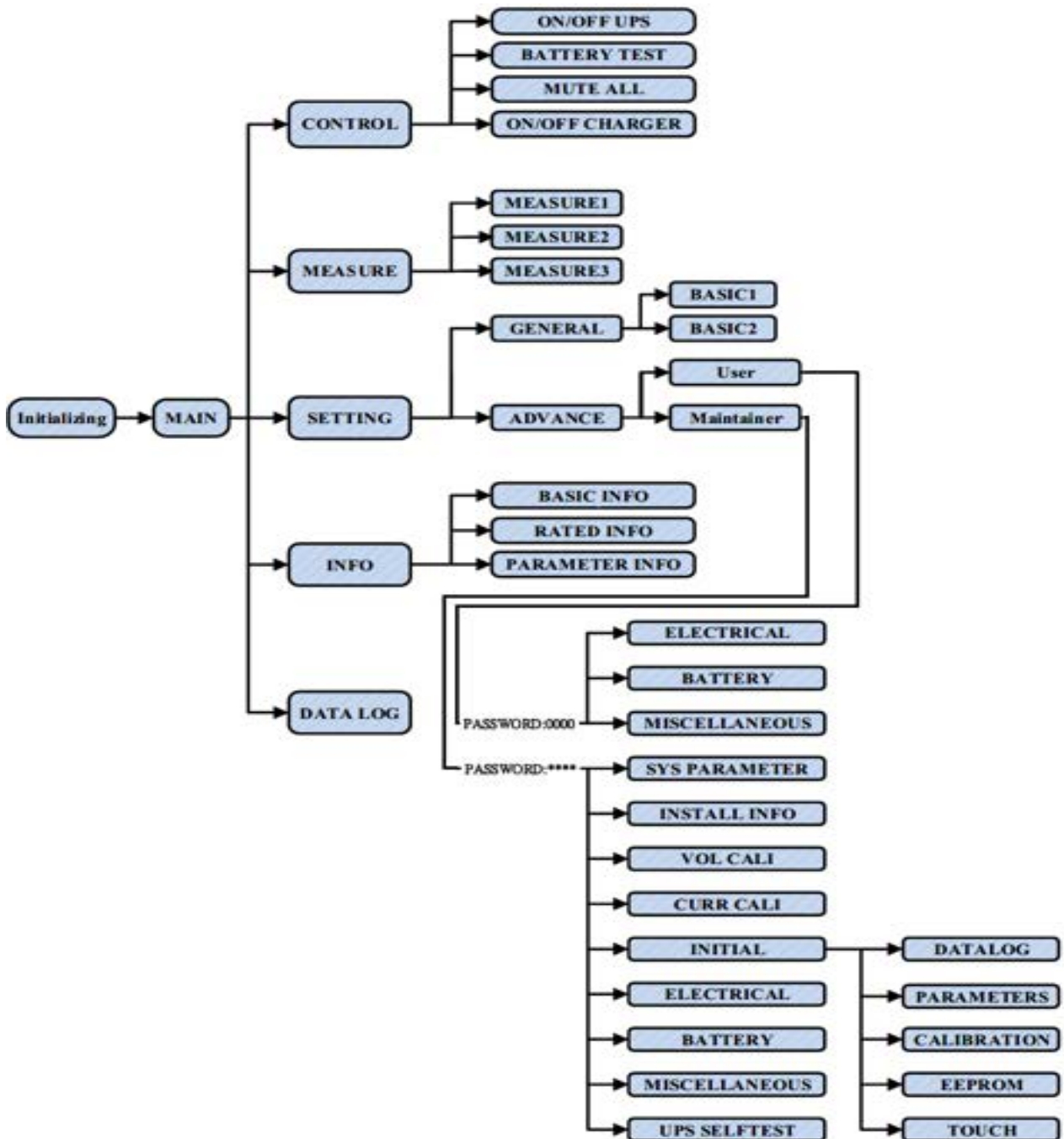

Menu tree

3-2-1 Main screen

Upon powering on, the LCD will start initialisation after a few seconds as shown below.



After initialisation, the main screen will display as shown below. On the bottom, there are five icons to represent five sub-menus: CONTROL, MEASURE, SETTING, INFO, DATALOG.

3-2-2 Control screen

Touch the icon  to enter control sub-menu.



Touch  icon to return back to main screen regardless of the screen of any submenu.

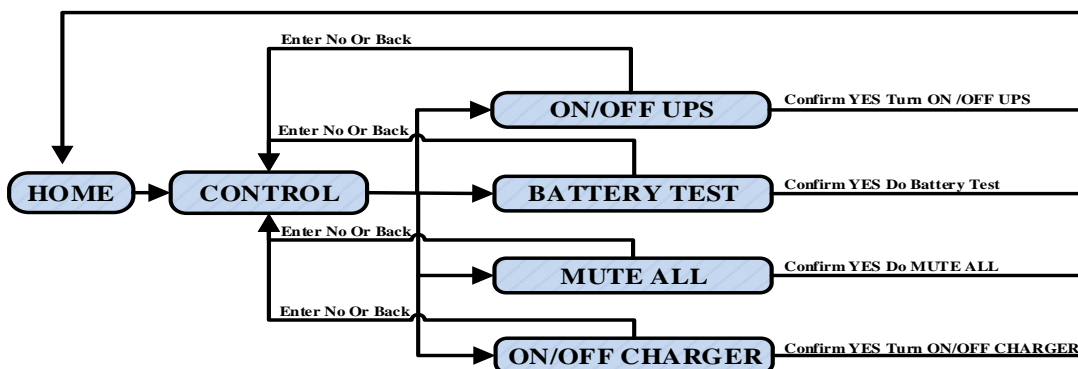

Screen 1.0 «Control» and its sub-menus

➤ **On/Off UPS**

It will show "Turn on UPS?" when UPS is off.

It will show "Turn off UPS?" when UPS is on.

Touch "YES" to turn on or off the UPS. Then, the screen will return to main screen.

Touch "Back" to return to main screen immediately or "No" to cancel this operation and back to main screen.



TURN ON UPS

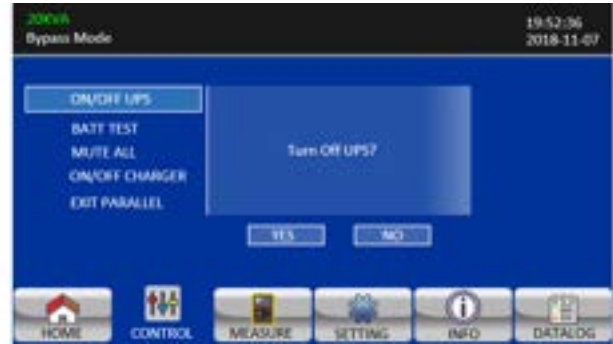

TURN OFF UPS

➤ **Battery Test**

It will show "Battery Test" if the UPS is not in test. Touch "Yes" to start battery test. Then, it will show "Battery testing....." during battery test period. After a few seconds, battery test result will show on the screen. Touch "Back" to return to main screen immediately or "No" to cancel this operation and back to main screen.

It will show "Cancel battery test" if the UPS is in test.



Battery Test



Cancel Battery Test

➤ **Audio mute**

It will show "Mute all" if the audio is active. Touch "Yes" to activate mute. If "Mute all" is active, it will show  icon on the top left corner of the main screen. Touch "Back" to return to CONTROL screen immediately or "No" to cancel this operation and back to CONTROL screen.

It will show "Cancel mute" if the UPS is mute already. Touch "Yes" activate audio function or "No" to keep mute. Touch "Back" to return to CONTRL screen.



Mute All



Cancel Mute all

➤ **On/Off Charger**

It will show "Turn on Charger?" when charger is off.

It will show "Turn off Charger?" when charger is on.

Touch "YES" to turn on or off the charger. Then, the screen will return to main screen.

Touch "Back" to return to CONTROL screen immediately or "No" to cancel this operation and back to CONTROL screen.



TURN ON CHARGER



TURN OFF CHARGER

➤ **EXIT PARALLEL**

In the case of multiple machines in parallel, clicking this option will pop up the "Exit Parallel?" interface; Click "Yes" to exit the machine from the current parallel system; Click "No" to cancel this operation and return to the operation interface.

In the case of a single machine, clicking this option will pop up the "This mode can't be SETUP!"







EXIT PARALLEL?



This mode can't be SETUP!!

3-2-3. Measure screen

Touch the icon  to enter measure page. Touch the icon  or  to browse information. Touch the icon  to return to main screen. Touch the icon  to go back to previous menu.



Measure screen page 1

- LINE VOL: The real time value of L1, L2 and L3 phase voltage, L1-L2, L2-L3, L3-L1 voltage and input frequency.
- INVERTER VOL: The real time value of L1 inverter voltage and frequency.
- BYPASS VOL: The real time value of L1 bypass voltage and frequency.
- OUTPUT VOL: The real time value of L1 output voltage and frequency.

20RVA Bypass Mode 19:52:36 2019-11-07

OUTPUT W	OUTPUT VA	Backup Time	0M 0S
L1: 4W	46VA	BATT P VOL	204.0V
		BATT N VOL	204.0V
		BUS P VOL	370.3V
		BUS N VOL	370.5V
		CHARG CURR	3.9A
		DISCHG CURR	0.0A
OUTPUT W(%)	OUTPUT VA(%)	TEMP L1	27
L1: 0%	0%	TEMP L2	27
		TEMP L3	27
TOTAL W(%)	TOTAL VA(%)		
0%	0%		

HOME CONTROL MEASURE SETTING INFO DATALOG

Measure screen page 2

- OUTPUT W: L1 output power in watt.
- OUTPUT VA: L1 output power in VA.
- OUTPUT W (%): L1 output power watt in percentage.
- OUTPUT VA (%): L1 output power VA in percentage.
- Total watt and VA: Total output load in watt and VA.
- Backup Time: Display battery backup time (Min & sec).
- BATT Voltage/Bus Voltage/Charging Current/Discharging Current: The real time value of DC related information.
- Temperature: Temperature of L1 = PFC Main Board, L2 = Inverter Main Board and L3 = bypass temp.

20RVA Bypass Mode 19:52:36 2018-11-07

INPUT W	INPUT VA	INPUT CURR	INPUT PF
L1: 4W	46VA	L1: 0.3A	0.08
L2: 4W	46VA	L2: 0.3A	0.08
L3: 4W	46VA	L3: 0.3A	0.08
INPUT W(%)	INPUT VA(%)	OUTPUT CURR	OUTPUT PF
L1: 0%	0%	L1: 0.3A	0.08
L2: 0%	0%		
L3: 0%	0%		
TOTAL W(%)	TOTAL VA(%)		
0%	0%		

HOME CONTROL MEASURE SETTING INFO DATALOG

Measure screen page 3

- INPUT W: L1, L2 and L3 input power in watt.
- INPUT VA: L1, L2 and L3 input power in VA.
- INPUT W (%): L1, L2 and L3 input power watt in percentage.
- INPUT VA (%): L1, L2 and L3 input power VA in percentage.
- Input current: The real-time value of input current in L1, L2 and L3 phases.
- Output current: The real-time value of output current in L1 phases.

3-2-4. Setting screen

This sub-menu is used to set the parameters of UPS. Touch the icon  to enter setting menu page.

There are 2 options: General and Advance. Touch the icon  to return to main screen. Touch the

icon  to go back to previous menu.

NOTE: Not all settings are available in every operation mode. If the setting is not available in present mode, the LCD will keep its original setting parameter showed instead of changing the parameters.



Setting screen

- **GENERAL:** Basic information of the UPS. Only function parameter's can be accessed.
- **ADVANCE:** Enter password to access to the "ADVANCE" setting. There are two types of authority, User and Maintainer.

GENERAL



General screen page 1

- **Language:** Set the LCD language.
- **Input Source:** Select the input source. There are two options: Line (utility) and generator. Line is default setting. This setting value will show on the main page. When "generator" is selected, the acceptable input frequency will be fixed at the range of 40~70Hz. This setting value will show on the status bar.
- **Service Contact:** Set the name of contact person and the maximum length is 18 characters.
- **Service Phone:** Set the service phone number. Only 0-9, + and - are accepted. The maximum length is 14 characters.
- **Service Mail:** Set the service email accounts up to two and the maximum length is 36 characters.





General screen page 2

➤ **Audio Alarm:** There are two events available to mute. You may choose "Enable" or "Disable" alarm when related events occur.

Enable: When selected, alarm will be mute when related events occur.

Disable: When selected, UPS will alarm when related events occur.

- All Mute: When "enable" is selected, all the faults and warnings will be mute. It will show  icon on the top right corner of the main screen.

- Mode Mute: UPS status mode alarm enable/disable. If "Mode Mute" is activated, it will show  icon on the top right corner of the main screen.

ADVANCE



Advance Password Page

It's required to enter password (4 digits) to access to the "ADVANCE" page.

➤ **ADVANCE →**

To access to the "Advance→User" Setting menu page, ENTER Password.

If entered password is right, the page will jump to setting screen. If the password is wrong, it will ask to enter again.



Password error page



Advance Setting Menu Page

There are three sub-menus under "Advance→User" setting: ELECTRONIC, BATTERY and MISCELLANEOUS.

ELECTRONIC



Electrical Setting Page 1

- Output Voltage: Select the output rated voltage.
 - There are four options, 208V, 220V, 230V and 240V.
- Output Frequency: Select output rated frequency.
 - **50Hz:** The output frequency is setting for 50Hz.
 - **60Hz:** The output frequency is setting for 60Hz.
- CVCF Mode (constant voltage and constant frequency function)
 - **Enable:** CVCF function is enabled. The output frequency will be fixed at 50Hz or 60Hz according to setting of "OP Freq.". The input frequency could be from 46Hz to 64Hz.
 - **Disable:** CVCF function is disabled. The output frequency will synchronize with the bypass frequency within 46~54 Hz for 50Hz system or within 56~64 Hz for 60Hz system. Disable is the default setting.
- Bypass Forbid:
 - **Enable:** Bypass forbid is enabled. When selected, running in Bypass mode under any situations is disabled.
 - **Disable:** Bypass forbid is disabled. When selected, UPS will run in Bypass mode depending on "Bypass at UPS off" setting. It is the default setting.
- NeutralLineCheck: Indicates neutral loss detection function.
 - **Disable:** Disable the neutral loss detection function. The UPS will not detect the neutral loss or not.
 - **Auto:** The UPS will automatically detect the neutral is lost or not. If neutral loss is detected, an alarm will be generated. If the UPS is turned on, it will transfer to battery mode. When neutral is restored and detected, the alarm will be muted automatically, and the UPS will go back to normal mode automatically.
 - **Check:** The UPS will automatically detect the neutral loss. If neutral loss is detected, an alarm will be generated. If the UPS is turned on, it will transfer to battery mode. When neutral is restored, the alarm will NOT be muted automatically, and the UPS will NOT go back to normal mode automatically.
- ISO Compensation: When the UPS output is connected to a transformer, the attenuation voltage of the voltage regulator is compensated.



Electrical Setting Page 2

- Bypass at UPS off: Select the bypass status when manually turning off the UPS. This setting is only available when "Bypass forbid." is set to "Disable".
 - **Enable:** Bypass enabled. When selected, bypass mode is activated.
 - **Disable:** Bypass disabled. When selected, no output passes through bypass when manually turning off the UPS.
- Bypass Voltage Range: Set the bypass voltage range.
 - **L:** Low voltage point for bypass. The setting range is 176V ~ 209V when UPS is HV system.
 - **H:** High voltage point for bypass. The setting range is 231V ~ 264V when UPS is HV system.
- Bypass FRE Range: Set the bypass frequency range.
The acceptable bypass frequency ranges from 46Hz to 54Hz when UPS is 50Hz system and from 56Hz to 64Hz when UPS is 60Hz system.
- ECO mode: Enable/Disable ECO mode. Default setting is "Disable".
- ECO Voltage Range: Set the ECO voltage range.
 - **L:** Low voltage point for ECO mode. The setting range is from "Rated output voltage – 5V" to "Rated output voltage - 11V". "Rated output voltage – 5V" is default setting.
 - **H:** High voltage point for ECO mode. The setting range is from "Rated output voltage + 5V" to "Rated output voltage + 11V". "Rated output voltage + 5V" is default setting.
- ECO FRE Range: Set the ECO frequency range. The setting range is from 46Hz to 54Hz when the UPS is 50Hz system and from 56Hz to 64Hz when the UPS is 60Hz system.

BATTERY



Battery setting page

- Battery Warning Voltage:
 - **HIGH:** High battery warning voltage. The setting range is 14.0V ~ 15.0V. 14.4V is default setting.
 - **LOW:** Low battery warning voltage. The setting range is 10.1V ~ 14.0V. 11.4V is default setting. This parameter setting is related to "Shutdown Voltage" setting. This setting value should be higher than "Shutdown Voltage" setting.
- Shutdown Voltage: If battery voltage is lower than this point in battery mode, UPS will automatically shut down. The setting range is 10.0V - 12.0V. 10.7V is default setting.
- Battery Age: Life expectancy of the battery installed; this setting will produce an Alarm (38 BATT Replace) when the duration has passed from the battery installation date.
- Battery Parameter:
 - Battery AH: setting battery capacity.





MISCELLANEOUS



Miscellaneous setting page

- Auto Restart:
 - **Enable:** After "Enable" is set, once UPS shutdown occurs due to low battery and then utility restores, the UPS will return to line mode.
 - **Disable:** After "Disable" is set, once UPS shutdown occurs and the utility restores, the UPS will not automatically turn on.
- Shutdown Delay Min: UPS will shut down in setting minutes. The countdown will start after confirming the pop-up screen.
- Restore Delay Min: UPS will automatically restart in setting minutes after the UPS shuts down.
- New Password: Set up new password to enter "ADVANCE➔ User" menu.

3-2-5. Information screen

Touch the icon  to enter information page. Touch the icon  or  to browse information. Touch the icon  to return to main screen. Touch the icon  to go back to previous menu.



Basic Information Page1

Basic Information

- MCU Version: MCU version.
- DSP Version: DSP version.
- Serial NO.: The serial number of UPS.
- Manufacturer: The information about manufacturer.
- Service Contact: The contact name is set in "Basic Setting".
- Service Phone: The listed numbers are set in "Basic Setting".
- Service Mail: The service email account is set in "Basic Setting".



Basic Information Page2

- PAR State: The information of parallel state.
- PAR ID: The UPS ID number in parallel state.



Rated Information Page

Rated Information

- Output Voltage: It shows output rated voltage.
- Output FRE: It shows output rated frequency.
- CVCF Mode: Enable/Disable CVCF mode.
- Bypass Forbid: Enable/disable bypass function.
- Bypass UPS Off: Enable/disable auto bypass function when UPS is off.
- Auto Restart: Enable/disable auto-restart function.
- ECO Mode: Enable/disable ECO function.



Parameter Information Page 1

Parameter Information





- Line Voltage Range: The acceptable line input voltage range.
- Line FRE Range: The acceptable line input frequency range.
- Bypass Voltage Range: The acceptable input voltage range for bypass mode.
- Bypass FRE Range: The acceptable input frequency range for bypass mode.
- ECO Voltage Range: The acceptable input voltage range for ECO mode.
- ECO FRE Range: The acceptable input frequency range for ECO mode.



Parameter Information Page 2

- BATT Mode Work Time: The maximum discharge time in battery mode.
- BATT Warning Voltage:
 - **HIGH:** High battery warning voltage.
 - **LOW:** Low battery warning voltage.
- Shutdown Voltage: If battery voltage is lower this point, UPS will automatically shut down.
- Shutdown Delay: UPS will shut down in setting minutes. The countdown will start after confirming the pop-up screen.
- Restore Delay: UPS will automatically restart in setting minutes after the UPS shuts down.
- Battery Number: Display's battery number quantity.

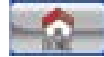
3-2-6. Data Log screen

Touch the icon  to enter data log page. Data log is used to record the warning and fault information of the UPS. The record contains date & time, code, type and description. Touch the icon  or  to page up or down if there are more than one page in the data log. Touch the icon  to return to main screen. Press the icon  to go back to main menu. Please refer to Section 3-6 and 3-7 for warning and fault code list.



Data Log Page

3-3. Audible Alarm

Description	Buzzer status	Muted
UPS status		
Bypass mode	Beeping once every 2 minutes	Yes
Battery mode	Beeping once every 4 seconds	
Fault mode	Beeping continuously	
Warning		
Overload	Beeping twice every second	No
Others	Beeping once every second	
Fault		
All	Beeping continuously	Yes

3-4. Single UPS Operation

1. Turn on the UPS with utility power (in AC mode)

- 1) After power supply is connected correctly, set the breaker of the battery pack at "ON" position (this step is only necessary for external battery). Then set the line input breaker, bypass breaker & output breaker to "ON" position. At this time the fan is running, and the UPS enters power on mode for initialisation, several seconds later, UPS operates in Bypass mode and supplies power to the load via the bypass.

NOTE: When UPS is in Bypass mode, the output voltage will directly power from utility after you switch on the input breaker. In Bypass mode, the load is not protected by the UPS. To protect your precious devices, you should turn on the UPS. Refer to next step.

- 2) Touch "CONTROL" and select "UPS on/off" icon. It will show "Turn on UPS?" in screen and select "Yes". Refer to On/Off UPS screen.
- 3) A few seconds later, the UPS will enter into AC mode. If the utility is abnormal, the UPS will operate in Battery mode without interruption.

NOTE: When the UPS running out battery, it will shut down automatically at Battery mode. When the utility is restored, the UPS will auto restart in AC mode.

2. Turn on the UPS without utility power supply (in Battery mode)

- 1) Make sure that the batteries are connected correctly at UPS's "+,GND,-" terminals and the breaker of the battery pack is at "ON" position.
- 2) Press the "⏻ **SERVICE START**" button to set up the power supply for the UPS. UPS will enter to power on mode. After initialisation, UPS will enter to No Output mode.
- 3) A few seconds later, the UPS will be turned on and enter to Battery mode.

3. Connect devices to UPS

After the UPS is turned on, you can connect devices to the UPS.

- 1) Turn on the UPS first and then switch on the devices one by one. The LCD panel will display total load level.
- 2) If it is necessary to connect the inductive loads such as a printer, the in-rush current should be calculated carefully to see if it meets the capacity of the UPS, because the power consumption of this type of load can be high.
- 3) If the UPS is overload, the buzzer will beep twice every second.
- 4) When the UPS is in overload, please remove some loads immediately. It is recommended to have the total loads connected to the UPS less than 80% of its nominal power capacity to prevent overload for system safety.
- 5) If the overload time is reached in the UPS spec at AC mode, the UPS will automatically transfer to Bypass mode. After the overload is removed, it will return to AC mode. If the overload time is reached in the UPS spec during Battery mode and if bypass is enabled, the UPS will power to the load via bypass. If bypass function is disabled or the input power is not within bypass acceptable range, it will cut off output directly.

4. Charge the batteries

- 1) After the UPS is connected to the utility power, the charger will charge the batteries automatically except in: battery mode, during battery self-test, overload or battery high voltage.
- 2) Suggest charging batteries at least 10 hours before use. Otherwise, the backup time may be shorter than expected.

5. Battery mode operation

- 1) When the UPS is in Battery mode, the buzzer will sound according to different battery capacity. If the battery capacity is more than 25%, the buzzer will beep once every 4 seconds. If the battery voltage drops to the alarm level, the buzzer will beep quickly (once every sec) to remind users that the battery is at low level and the UPS will shut down automatically soon.
Users could switch off some non-critical loads to disable the shutdown alarm and prolong the backup time. If there is no more load to be switched off at that time, you have to shut down all loads as soon as possible to protect the devices or save data. Otherwise, there is a risk of data loss or load failure.
- 2) In Battery mode, users can touch "SETTING" → "Basic" → Audio Mute to enable "Mode Mute" to disable the buzzer.
- 3) The backup time of the long-run model depends on the external battery capacity.
- 4) The backup time depends on the environment's temperature and load type.
- 5) When setting backup time for 16.5 hours (default value from LCD menu), after discharging 16.5 hours, UPS will shut down automatically to protect the battery. This battery discharge protection can be enabled or disabled through LCD menu.

6. Test the batteries

- 1) If you need to check the battery status when the UPS is running in AC mode/CVCF mode, you could touch "CONTROL" and select "Battery Test". Refer to "Battery Test" screen.
- 2) Users also can set battery self-test through monitoring software.

7. Turn off the UPS with utility power supply in AC mode

- 1) Touch "CONTROL" and select "Turn off UPS" icon to turn off the UPS. Refer to "UPS on/off" screen.

NOTE 1: If the UPS has been set to bypass output, it will bypass voltage from the utility power to output terminal even though you have turned off the UPS (inverter).

NOTE 2: After turning off the UPS, please be aware that the UPS is working at Bypass mode and there is risk of power loss for connected devices.

- 2) In Bypass mode, output voltage of the UPS is still present. In order to cut off the output, switch off the line input breaker, bypass breaker and output breaker. A few seconds later the display will shut down and the UPS will completely turn off. Please note DC voltage is still present internal to the system!

8. Turn off the UPS without utility power supply in Battery mode

- 1) Touch "CONTROL" and select "Turn off UPS" icon to turn off the UPS. Refer to "UPS on/off" screen.
- 2) Then UPS will cut off power to output terminals.

9. Mute the buzzer

- 1) Touch "SETTING" and select "BASIC" item. There are two options available to mute. Refer to "SETTING" screen.
- 2) Some warning alarms can't be muted unless the error is resolved. Please refer to section 3-3 for details.

10. Operation in warning status

- 1) When Fault LED illuminates and the buzzer beeps once every second, there are problems for UPS operation. Users can read the warning message(s) from "DATA LOG" menu. Please refer to the Section 3-2-6 for details.

11. Operation in Fault mode

- 1) When Fault LED illuminates and the buzzer beeps continuously, it means that there is a major error with the UPS. Users can get the fault code from "DATA LOG" menu. Please refer to the Section 3-2-6 for details.
- 2) Please check the loads, wiring, ventilation, utility, battery after the fault occurs. Don't try to turn on the UPS again before solving the issue. If the problems can't be fixed, please contact the distributor or service personnel immediately.
- 3) For emergency case, please cut off connection from utility, external battery, and output immediately to avoid possible damage to the UPS or equipment.

12. Operation in maintenance bypass mode

This operation is only available for professional or qualified technicians.

When the UPS needs repair or service and then the load can't be shut off, the UPS needs to turn to maintenance mode.

- 1) First, turn off the UPS (Bypass enabled -Active setting must be checked before turning off UPS!)
- 2) Second, remove the cover of maintenance bypass switch on the panel.
- 3) Third, turn the maintenance switch to "BPS" position and turn off the UPS input breaker and output breaker.

3-5. Parallel Operation

1. Parallel system initial startup

Please make sure that all of the running UPSs are parallel models and have the same configuration.

- 1) Turn on each UPS in AC mode respectively (Refer to section 3-4(1)). Then, measure the inverter output voltage of each phase for each UPS with a multi-meter. Calibrate the inverter output voltage by configuring inverter voltage adjustment (Refer to SETTING → VOL CALI screen) in LCD menu until the inverter output voltage difference of each UPS is within 1V or less.
- 2) Turn off each UPS (Refer to section 3-4(7.)). Then, follow the wiring procedure in section 2-4.
- 3) Remove the cover of parallel share current cable port on the UPS, connect each UPS one by one with the parallel cable and share current cable, and then screw the cover back.
- 4) **Turn on the parallel system in AC mode:**
 - a) Turn on the line input and bypass breaker of each UPS. After all UPSs enter to bypass mode, measure the output phase to phase voltage between all units to make sure the phase sequence is correct. If voltage differences are near to zero, that means all connections are met. Otherwise, please check if the wirings are connected correctly.
 - b) Turn on the output breaker of each UPS.
 - c) Turn on each UPS in turns. After a while, the UPSs will enter to AC mode synchronously and then, the parallel system initialisation process is complete.
- 5) **Turn on the parallel system in Battery mode:**
 - a) Turn on the battery breaker and output breaker of each UPS.
 - b) Turn on any UPS. A few seconds later, the UPS will enter to battery mode.
 - c) Turn on another UPS. A few seconds later, the UPSs enter to Battery mode and add to the parallel system.
 - d) If you have the third UPS, follow the same procedure of c). Then, the parallel system is complete.

If you would like to have more information regarding to the parallel operation, please contact your supplier or service centre for detail parallel operation instruction.

2. Add new units into the parallel system

- 1) You cannot add a new unit into the parallel system when the whole system is running. You must cut off the load and shutdown the system or transfer load to external bypass mode if available.
- 2) Make sure all of the UPS are parallel models, and follow the wiring refer to section 2-4.
- 3) Install the new parallel system refers to the previous section.

3. Remove units from the parallel system

Check that Mains and Bypass Supplies are both healthy.

COMPLETE THE FOLLOWING ON UNIT TO BE REMOVED:

- 1) Touch "CONTROL" → "Exit Parallel" and select "Yes" to turn of the UPS. If the system has available redundancy the UPS will disconnect its output and the other UPS units will continue to feed the load. If there is no redundancy within the UPS units, the load will transfer to bypass.
- 2) Turn off the output breaker of this unit, and then turn off the input and bypass breaker of this unit.
- 3) After UPS shuts down, you can turn off the battery breaker and remove the parallel and share current cables. Then remove the unit from the parallel system.

NOTE1: IF "ON/OFF UPS" is selected all UPS will transfer to bypass.

NOTE2: If the bypass is abnormal and there is no redundancy available removing a UPS from parallel could cause disruption to the load.

NOTE3: Make sure the bypass setting is enabled in each UPS.



Warning: (Only for the parallel system)

- Before turning on the parallel system to activate inverter, make sure that all units maintenance bypass switches are in the same position.
- When parallel system is turned on, please do not operate the maintenance switch of any unit if the system is operating in capacity and not redundancy.
- Please Do NOT enable the ECO mode in parallel system.

3-6. Fault Code

Code	Fault event	Icon	Code	Fault event	Icon
01	Bus start failure	None	43	Overload	None
02	Bus over	None	46	Incorrect UPS setting	None
03	Bus under	None	47	MCU communication failure	None
04	Bus unbalance	None	48	Two DSP firmware versions are incompatible in parallel system.	None
06	Converter over current	None	60	Bypass phase short circuited	None
11	Inverter soft start failure	None	61	Bypass SCR short circuited	None
12	High inverter voltage	None	62	Bypass SCR open circuited	None
14	Inverter A output(line to neutral) short circuited	None	63	Voltage waveform abnormal in A phase	None
15	Inverter B output(line to neutral) short circuited	None	64	Voltage waveform abnormal in B phase	None
16	Inverter C output(line to neutral) short circuited	None	65	Voltage waveform abnormal in C phase	None
1A	Inverter A negative power fault	None	66	Inverter current detect abnormal	None
1B	Inverter B negative power fault	None	67	Bypass O/P short circuited	None
1C	Inverter C negative power fault	None	68	Bypass O/P line to line short circuited	None
21	Battery SCR short circuited	None	69	Inverter SCR short circuited	None
23	Inverter relay circuited open	None	6C	BUS voltage drops too fast	None
24	Inverter relay short circuited	None	6D	Current error value detect	None
25	Line wiring fault	None	6E	SPS power error	None
31	Parallel communication failure	None	6F	Battery polarity reverse	None
32	The host signal failure	None	71	PFC IGBT over-current in A phase	None
33	Synchronous signal failure	None	72	PFC IGBT over-current in B phase	None
34	Synchronous trigger signal failure	None	73	PFC IGBT over-current in C phase	None
35	Parallel communication loss	None	74	INV IGBT over-current in A phase	None
36	Parallel output current unbalance	None	75	INV IGBT over-current in B phase	None
38	Battery has reached end of life expectancy	None	76	INV IGBT over-current in C phase	None
41	Over temperature	None	77	ISO Over temperature	None
42	DSP communication failure	None	78	LCD&MCU communication failed	None

3-7. Warning Code

Code	Warning event	Code	Warning event
01	Battery unconnected	21	Line situations are different in parallel system
02	IP Neutral loss	22	Bypass situations are different in parallel system
04	IP phase abnormal	33	Locked in bypass after overload 3 times in 30 minutes
05	Bypass phase abnormal	34	Converter current unbalanced
07	Over charge	3A	Cover of maintain switch is open
08	Low battery	3C	Utility extremely unbalanced
09	Overload	3D	Bypass is unstable
0A	Fan failure	3E	Battery voltage too high
0B	EPO enable	3F	Battery voltage unbalanced
0D	Over temperature	40	Charger short circuited
0E	Charger failure		

4. Trouble Shooting

If the UPS system does not operate correctly, please solve the problem by using the table below.

Symptom	Possible cause	Remedy
No indication and alarm in the front display panel even though the mains is normal.	The AC input power is not connected well.	Check if input cable firmly connected to the mains.
The warning code 0B.	EPO function is activated. At this time, the EPO switch is in "OFF" status or the jumper is open.	Set the circuit in closed position to disable the EPO function.
The warning code 01.	The external or internal battery is incorrectly connected.	Check if all batteries are connected properly.
The warning code 09.	UPS is in overload condition.	Remove excess loads from UPS output.
	UPS is overloaded. Devices connected to the UPS are fed directly by the electrical network via the Bypass.	Remove excess loads from UPS output.
	After repetitive overloads, the UPS is locked in the Bypass mode. Connected devices are fed directly by the mains.	Remove excess loads from UPS output first. Then shut down the UPS and restart it.
Fault code is shown as 43.	UPS is in overload too long and goes into fault mode. Then UPS shut down automatically.	Remove excess loads from UPS output and restart it.
Fault code is shown as 14, 15, 16	The UPS shut down automatically because short circuit occurs on the UPS output.	Check output wiring and if connected devices are in short circuit status.
Other fault codes are shown on LCD display and alarm beeps continuously.	A UPS internal fault has occurred.	Contact Kohler
Battery backup time is shorter than nominal value.	Batteries are not fully charged.	Charge the batteries for at least 7 hours and then check capacity. If the problem still persists, consult your dealer.
	Batteries defect	Contact Kohler to replace the battery.
The warning code 0A.	Fan is locked or not working. Or the UPS temperature is too high.	Check fans and notify Kohler.
The warning code 02.	The input neutral wire is disconnected.	Check and correct the input neutral connection. If the connection is ok and the warning is still displaying, please refer to the LCD setting section, to enter the neutral loss check menu, to see if the parameter3 is "CHE". If it is, please press the "Enter" key firstly to make the "CHE" flash and press the "Enter" key secondly to make the UPS clear the alarm. If the warning still exists, please check input fuses of L2 and L3.
	The L2 or L3 input fuse is broken.	Replace the fuse.

5. Storage and Maintenance

5-1. Storage

Before storing, charge the UPS for at least 7 hours. Store the UPS covered and upright in a cool, dry location. During storage, recharge the battery in accordance with the following table:

Storage Temperature	Recharge Frequency	Charging Duration
-25°C - 40°C	Every 3 months	1-2 hours
40°C - 45°C	Every 2 months	1-2 hours

5-2. Maintenance



The UPS system operates with hazardous voltages. Repairs may be carried out only by qualified maintenance personnel.



Even after the unit is disconnected from the mains, components inside the UPS system are still connected to the battery packs which are potentially dangerous.



Before carrying out any kind of service and/or maintenance, disconnect the batteries and verify that no current is present and no hazardous voltage exists in the terminals of high capability capacitor such as BUS-capacitors.



Only trained battery engineers who understand the required precautionary measures may replace batteries and supervise operations.



Verify that no voltage between the battery terminals and the ground is present before maintenance or repair. The UPS has a centre tapped battery that is connected to Neutral. Hazardous voltages may occur between the battery terminals and the grounding/ earthing.



Batteries may cause electric shock and have a high short-circuit current. Please remove all wristwatches, rings and other metal objects before maintenance or repair, and only use tools with insulated grips and handles for maintaining or repairing.



When replace the batteries, install the same number and same type of batteries.



Do not attempt to dispose of batteries by burning them. This could cause battery explosion. The batteries must be disposed of according to local environmental regulations.



Do not open or destroy batteries. Escaping electrolyte can cause injury to the skin and eyes. It may be toxic.



Please replace the fuse only with the same type and amperage in order to avoid fire hazards.



Do not disassemble the UPS system.

6. Specifications

MODEL		PW3000/P1 10K	PW3000/P1 20K
CAPACITY*		10KVA / 10KW	20KVA / 20KW
INPUT			
Voltage Range	Low Line Loss	110 VAC(Ph-N) \pm 3 % at 50% Load 176 VAC(Ph-N) \pm 3 % at 100% Load	
	Low Line Comeback	Low Line Loss Voltage + 10V	
	High Line Loss	300 VAC(L-N) \pm 3 % at 50% Load 276 VAC(L-N) \pm 3 % at 100% Load	
	High Line Comeback	High Line Loss Voltage - 10V	
Frequency Range		46Hz ~ 54 Hz @ 50Hz system 56Hz ~ 64 Hz @ 60Hz system	
Phase		3 Phase with Neutral OR Single Phase with Neutral (Single or Dual)	
Power Factor		\geq 0.99 at 100% Load	
OUTPUT			
Phase		Single phase with Neutral	
Output voltage		220/230/240VAC (Ph-N)	
AC Voltage Regulation		\pm 1%	
Frequency Range (Synchronized Range)		46Hz - 54 Hz @ 50Hz system 56Hz - 64 Hz @ 60Hz system	
Frequency Range (Batt. Mode)		50 Hz \pm 0.1 Hz or 60Hz \pm 0.1 Hz	
Overload	AC mode	100% -110%: 60min; 110% -125%: 10min; 125% -150%:1min;>150% : immediately	
	Battery mode	100%~110%: 60min; 110%~125%: 10min; 125%~150%:1min;>150% : immediately	
Current Crest Ratio		3:1 max	
Harmonic Distortion		\leq 2 % @ 100% Linear Load; \leq 5 % @ 100% Non-linear Load	
Transfer Time	Line \leftrightarrow Battery	0 ms	
	Inverter \leftrightarrow Bypass	0 ms (When phase lock fails, <4ms interruption occurs from inverter to bypass)	
	Inverter \leftrightarrow ECO	<10 ms	
EFFICIENCY			
AC mode		96.6%	
Battery Mode		95.5%	
Eco Mode		99.0%	
BATTERY			
	Numbers	(10+10)pcs Up to 2 strings Internal – 40pcs	Max (20+20) pcs Up to 1 String Internal – 40pcs
	Recharge Time	9 hours recover to 90% capacity	
	Charging Current (max)	2.0 A \pm 10% (Recommended) 1.0~12.0A (Adjustable)	
	Charging Voltage	+/-136.5 VDC \pm 1%	+/-218 VDC \pm 1%
	Type	Depending on applications	
	Numbers	20	32 ~ 40 (adjustable)
	Charging Voltage	+/- 13.65 VDC * N \pm 1% (N = 10)	+/- 13.65 VDC * N \pm 1% (N = 16~20)
PHYSICAL			
Standard Model	Dimension, D x W x H (mm)	710 x 250 x 827	
	Net Weight (kgs)	141	141
ENVIRONMENT			
Operation Temperature		0 - 40°C (A temperature of 20°C is recommended to achieve a long battery life)	
Operation Humidity		<95 % and non-condensing	
Operation Altitude**		<1000m**	
Acoustic Noise Level		Less than 55dB @ 1 Metre	Less than 58dB @ 1 Metre
MANAGEMENT			
Smart RS-232 or USB		Supports Windows® 2000/2003/XP/Vista/2008/7/8/10, Linux, Unix, and MAC	
Optional SNMP		Power management from SNMP manager and web browser	

* Derate capacity to 90% when the output voltage is adjusted to 208VAC.

**If the UPS is installed or used in a place where the altitude is above than 1000m, the output power must be de-rated 1% per 100m.

***Product specifications are subject to change without further notice.

7. Options

7-1 SNMP CARD - OPTIONAL

SNMP (Simple Network Management Protocol) card for monitoring the Kohler PW UPS.

The SNMP Card provides the ability to monitor the UPS remotely and provide some control.

Features:

- SNMP Trap V1, V2, V3 to monitor & control UPS
- Support TCP/IP, UDP, SNMP, Telnet, SNTP, PPP, HTTP, HTTPS, SMTP, FTP, Modbus, BACnet Protocols
- Support SSL/TLS, SSH Encryptions
- Provides UPS log files
- Provides easy setup and upgrade tools
- Send E-mail, SMS and Email trap for events notification.
- Perform graceful shutdown
- Add-on optional Environmental Monitoring i.e., temperature, humidity, water, smoke, door sensor etc.
- Add-on optional GPRS modem for SMS notification

Applications

Provides UPS monitoring via Network

When the UPS connects with SNMP, the user can check each UPS condition via a computer with an installed Browser. The user can monitor and control the UPS by entering the SNMP card IP address into the browser search. During an abnormal power condition, the SNMP can send the information directly to the user.

Provides Shutdown Utilities

The computer/server must install the provided shutdown software and the device must be connected to the same network as the SNMP. When the UPS goes into an AC failure condition or Battery Low condition, the software can close all running files of the operating system and shutdown gracefully.

This avoids system corruption when a power disconnection happens.

Provides Environmental Monitoring

The SNMP can connect to optional sensor- to import the temperature/humidity/smoke/fire signals. Information is displayed on the SNMP Web page.

If an abnormal condition happens a trap can be sent directly to the user.

CONTACT DETAILS

Kohler Uninterruptible Power
Woodgate,
Bartley Wood Business Park
Hook
Hampshire
RG27 9XA
United Kingdom

Telephone: +44 (0) 1256 386 700

Website: www.kohler-ups.co.uk

KUP Technical Support: uktechnicalsupport.ups@kohler.com